

MAC 25-3



Features: MAC 25-3

- ▶ 25 tonne at 1.41 m radius
- ▶ 1.8 tonne at 15.71 m radius
- ▶ 18 m maximum hook height
- ▶ Hook block (6 parts) capacity 25 tonne
- ▶ Single line 4.2 tonne

Key

..... 3

Dimensions

Crane dimensions 4, 5
Range diagram 6
Area of operation 7

Load charts

Fallblock, Front counterweight
 Third boom retracted 8
 Third boom extending 9
Fallblock, Rear counterweight
 Third boom retracted 10
 Third boom extending 11

Technical description

Boom and Jib 12
Winch 12
Engine and transmission 12
Hydraulic system 13
Chassis 13
Tyres 13
Vehicle performance 14
Cab, controls, and operator aids 14

	Boom length		Speed
	Hook height		Slewing / Allowable slewing range
	Boom with jib		Crane / Crane in standard configuration
	Telescoping mode		Gradeability
	Boom elevation angle		Gross vehicle weight
	Working radius		Counterweight on front
	Hook and block		Counterweight on rear
	On rubber		Controls
	Main winch		Cab
	Winch speed		Air conditioning / Cab heating
	Engine		Operator aids / Load limiter / Load indicator
	Transmission		Rope – Standard / Optional
	Hydraulics		Rope diameter
	Steering		Rope length
	Tyres		Maximum line pull

DIMENSIONS

MAC 25-3

Crane Dimensions

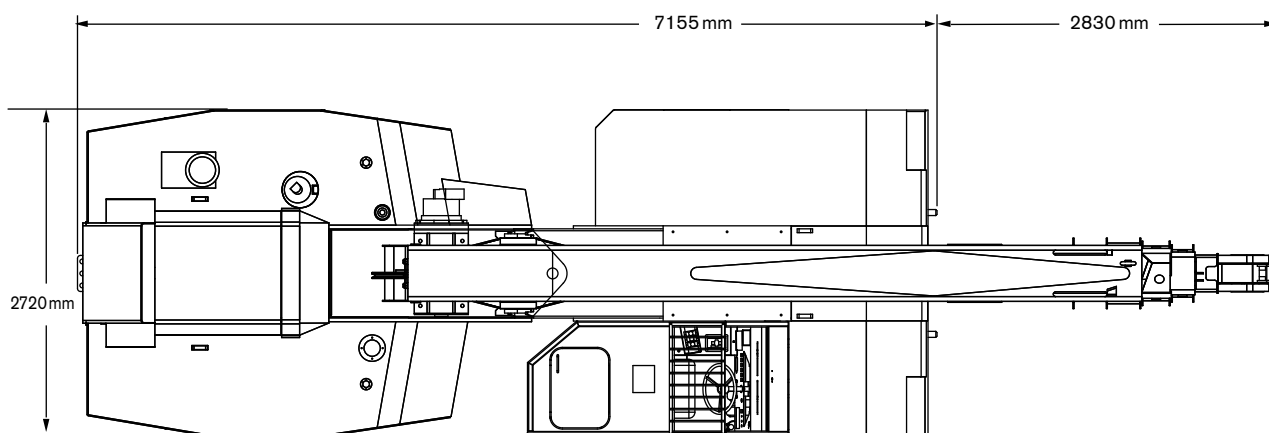
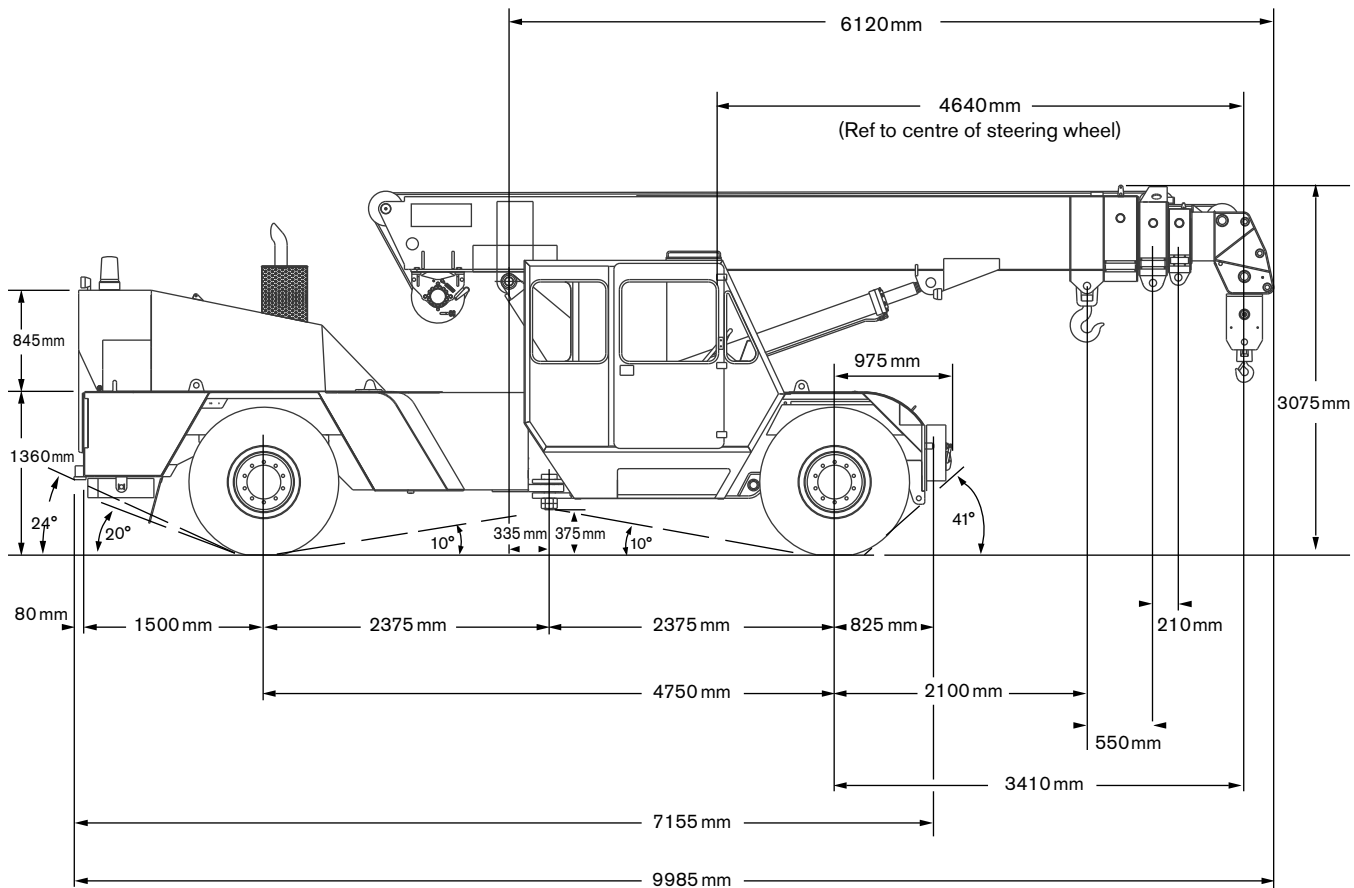

DIMENSIONS

MAC 25-3

Crane Dimensions

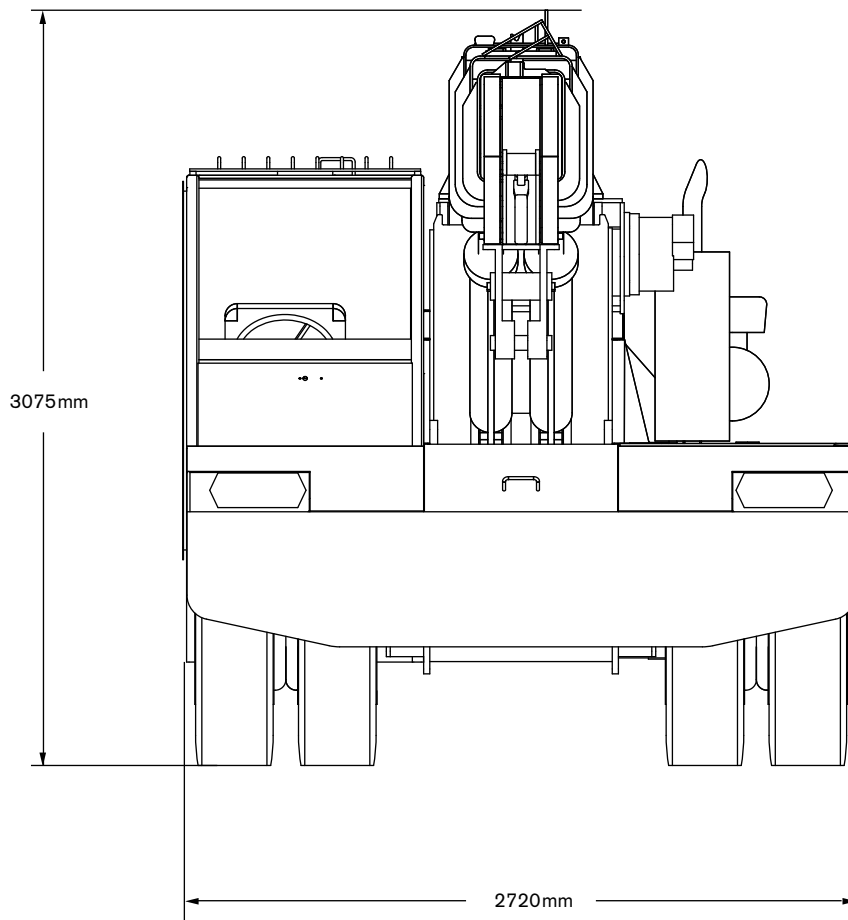

RADIUS LOAD CHART

MAC 25-3

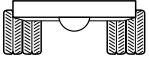

Pick & Carry 0.4m/s (1.44 km/h); On rubber 66.6%

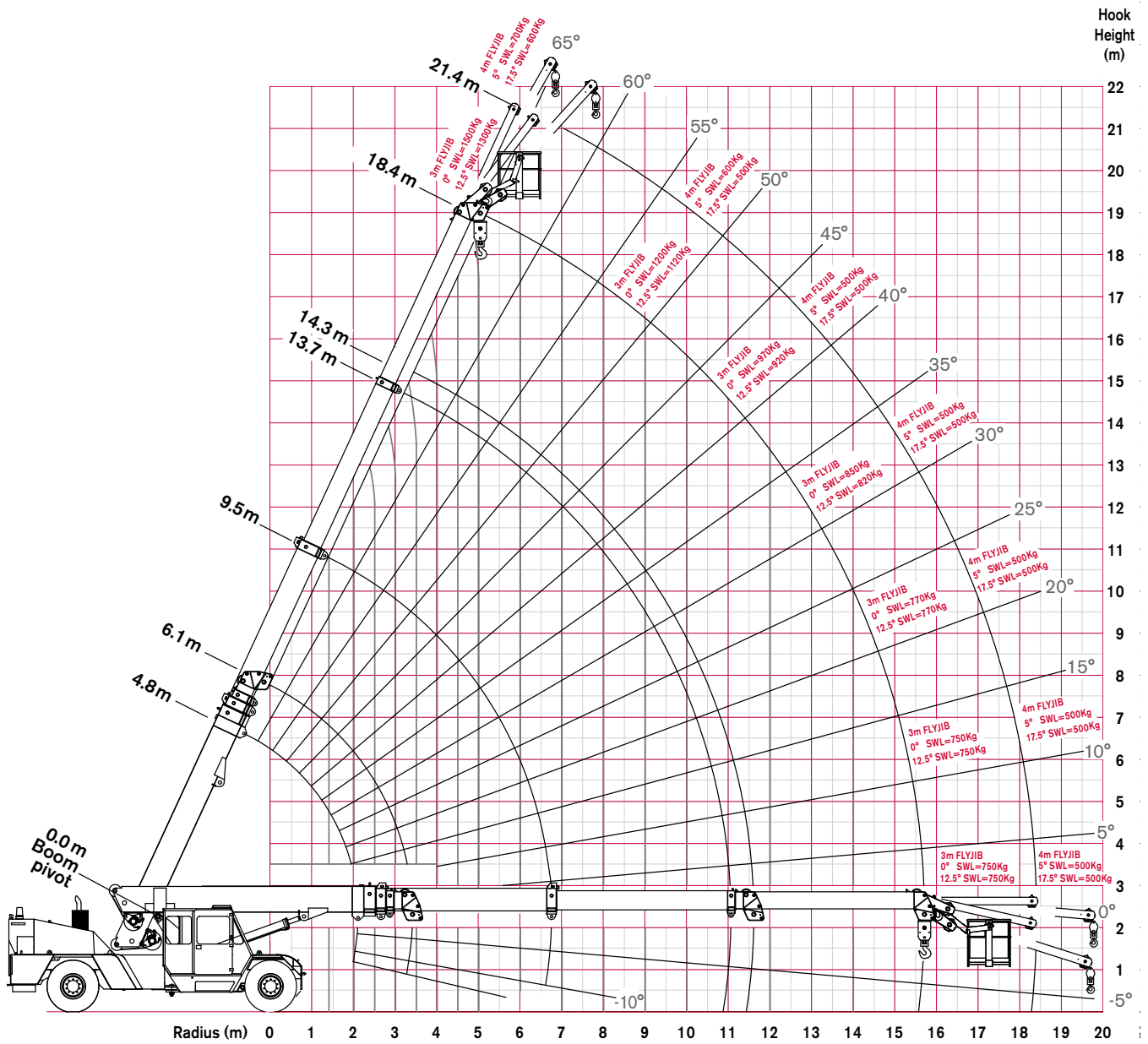

Radius (m)	0	1	2	3	4	5	6	7	8	9	10	11	12	13	14	15	16	17	18	19	20	
SWL (tonnes) 10° ARTIC	25	23	18	14.9	12.5	10.7	8.9	6.6	5.4	4.6	4.0	3.5	2.7	2.1	1.8							
SWL (tonnes) 40° ARTIC	25	20	16	13.3	11.1	9.5	7.3	5.8	4.7	3.9	3.3	2.9	2.3	1.8	1.5							

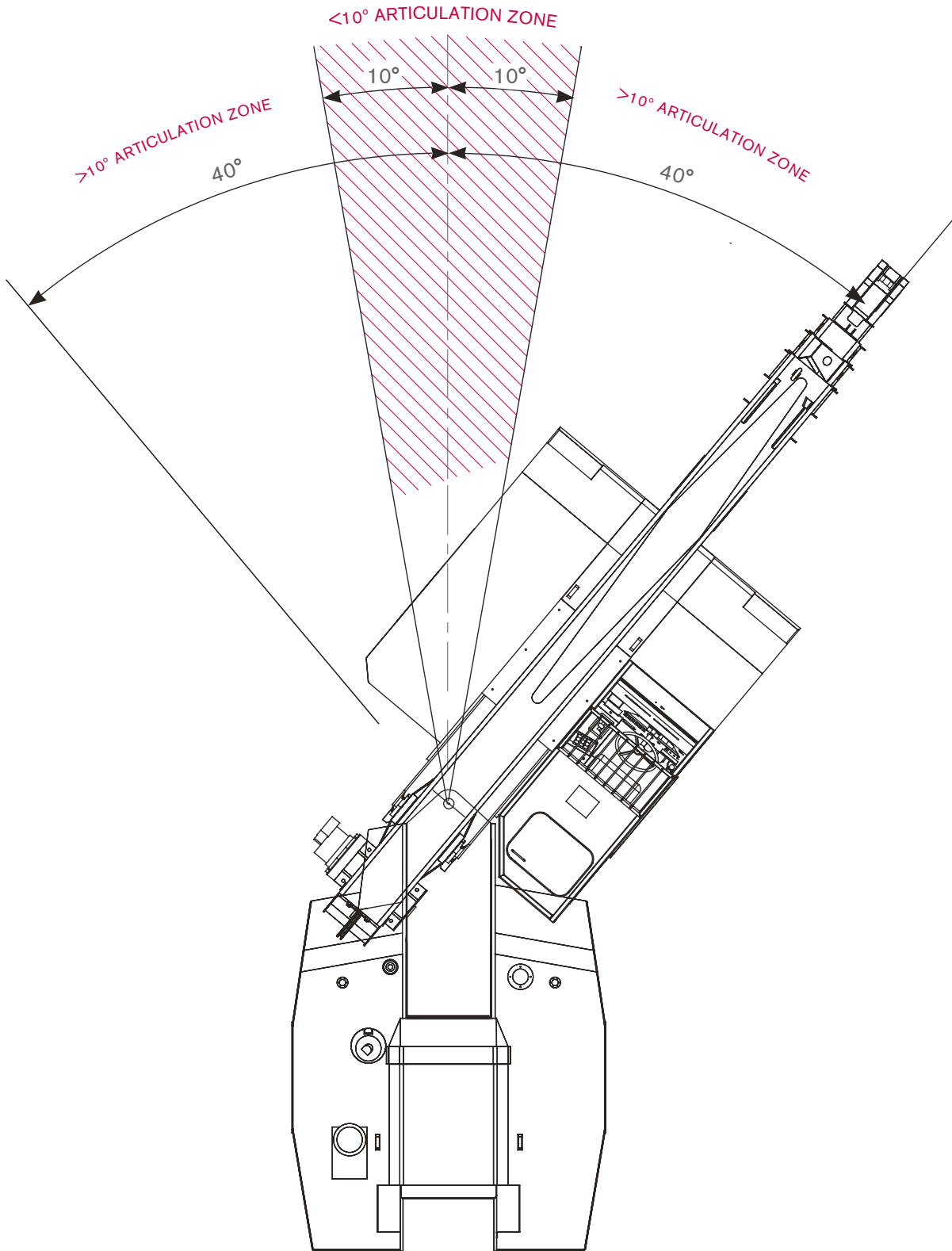

LOAD CHART

MAC 25-3

Fallblock, Front Counterweight, 3rd Boom Retracted

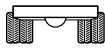

Pick & Carry 0.4 m/s (1.44 km/h); On rubber 66.6%



6.12–14.32 m

AS 1418.5

		Boom Length (m)																		
		6.12	6.50	7.00	7.50	8.00	8.50	9.00	9.50	10.00	10.50	11.00	11.50	12.00	12.50	13.00	13.50			14.32
m	kg	kg	kg	kg	kg	kg	kg	kg	kg	kg	kg	kg	kg	kg	kg	kg	kg	kg	m	
1.4	23900	23850	23750	23800	23800	23750	23750	23750											1.4	
	23750	22450	20950	19200	17750	16600	15600	14750												
	48°	51°	54°	57°	59°	61°	63°	65°												
2.0	19950	19900	19850	19800	19750	19750	19700	19650	19650	19600	19300								2.0	
	17850	17850	17800	16850	15950	15150	14500	13750	13000	12350	11750									
	40°	44°	48°	51°	54°	57°	59°	61°	62°	64°	65°									
2.5	15700	15650	15600	15600	15550	15500	15500	15450	15450	15400	15400	15350	14600						2.5	
	14000	14000	13950	13900	13900	13400	12800	12300	11800	11400	10950	10500	10050							
	32°	37°	42°	46°	50°	52°	55°	57°	59°	61°	62°	63°	65°							
3.0	12800	12800	12800	12750	12700	12700	12650	12650	12600	12600	12600	12550	12550	12550	12500	12250			3.0	
	11450	11400	11400	11350	11350	11300	11300	10950	10550	10150	9800	9500	9200	8950	8600	8300				
	21°	29°	35°	41°	45°	48°	51°	53°	55°	57°	59°	61°	62°	63°	64°	65°				
3.5	11050	10750	10750	10750	10700	10700	10650	10650	10600	10600	10600	10550	10550	10550	10500	10500	10500		3.5	
	9800	9550	9550	9550	9500	9500	9450	9450	9450	9150	8850	8550	8300	8050	7850	7650	7300			
	(3.4)	17°	28°	34°	39°	43°	47°	49°	52°	54°	56°	58°	59°	61°	62°	63°	65°			
4.0	9750	9200	9200	9200	9150	9150	9150	9100	9100	9100	9100	9050	9050	9050	9050	9000	9000		4.0	
	8650	8150	8150	8150	8150	8100	8100	8050	8050	8050	8000	7750	7550	7350	7150	6950	6650			
	(3.8)	17°	27°	33°	38°	42°	45°	48°	51°	53°	55°	56°	58°	59°	61°	62°				
5.0	8450	7400	7050	7050	7050	7000	7000	7000	6950	6950	6950	6950	6950	6950	6900	6900		5.0		
	7450	6500	6200	6200	6200	6200	6150	6150	6150	6150	6100	6100	6100	6000	5800	5600				
	(4.3)	(4.8)	16°	25°	31°	36°	40°	43°	46°	48°	50°	52°	54°	56°	58°					
6.0	6550	5850	5600	5600	5600	5600	5600	5550	5550	5550	5550	5550	5550	5550	5500	5500		6.0		
	5750	5100	4900	4900	4900	4900	4850	4850	4850	4850	4850	4850	4850	4850	4750					
	(5.3)	(5.8)	15°	24°	30°	34°	38°	41°	44°	46°	48°	50°	53°							
7.0	5250	4750	4550	4550	4550	4550	4550	4550	4550	4550	4550	4550	4550	4500	4500		7.0			
	4600	4100	3950	3950	3950	3950	3950	3950	3950	3950	3950	3950	3950	3900	3900					
	(6.3)	(6.8)	14°	23°	28°	33°	36°	39°	42°	44°	48°									
8.0	4300	3900	3800	3800	3800	3800	3800	3800	3800	3800	3800	3800	3800	3750	3750	3750		8.0		
	3700	3400	3250	3250	3250	3250	3250	3250	3250	3250	3250	3250	3250	3250	3250	3250				
	(7.3)	(7.8)	14°	22°	27°	31°	35°	38°	42°											
9.0	3600	3300	3200	3200	3200	3200	3200	3200	3200	3200	3200	3200	3200	3200	3150		9.0			
	3100	2800	2700	2700	2700	2700	2700	2700	2700	2700	2700	2700	2700	2700	2700					
	(8.3)	(8.8)	13°	21°	26°	30°	35°													
10	3000	2800	2700	2700	2700	2700	2700	2700	2700	2700	2700	2700	2700	2700	2700		10			
	2550	2350	2300	2300	2300	2300	2300	2300	2300	2300	2300	2300	2300	2300	2300					
	(9.3)	(9.8)	12°	20°	28°															
11	2550	2350	2300	2300	2300	2300	2300	2300	2300	2300	2300	2300	2300	2300	2300		11			
	2150	2000	1950	1950	1950	1950	1950	1950	1950	1950	1950	1950	1950	1950	1950					
	(10.3)	(10.8)	17°																	
12	2100	2100	2100	2100	2100	2100	2100	2100	2100	2100	2100	2100	2100	2100	2100		12			
	1750	1750	1750	1750	1750	1750	1750	1750	1750	1750	1750	1750	1750	1750	1750					
	(11.6)																			
13																		13		
14																		14		
15																		15		
15.71																		15.71		

- RC (kg) < than 10° articulation
- RC (kg) > than 10° articulation
- Boom angle
- Radius at 0° boom angle
- Loads above red line are structural

Notes to lifting capacity

Lifting capacities do not exceed 66.6% of tipping load. Weight of hook blocks and slings is part of the load, and is to be deducted from the capacity ratings. Consult Rated Capacity Manual for further details.

Data published herein is intended as a guide only and shall not be construed to warrant applicability for lifting purposes. Crane operation is subject to the computer charts and Rated Capacity Manual both supplied with the crane.

LOAD CHART

MAC 25-3

Fallblock, Front Counterweight, 3rd Boom Extending

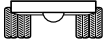

Pick & Carry 0.4m/s (1.44 km/h); On rubber 66.6%



14.50–18.42 m

AS 1418.5

m	Boom Length (m)									m
	14.50	15.00	15.50	16.00	16.50	17.00	17.50	18.00	18.42	
kg	kg	kg	kg	kg	kg	kg	kg	kg	kg	kg
1.4										1.4
2.0										2.0
2.5										2.5
3.0										3.0
3.5	10500									3.5
	7250 65°									
4.0	9000	9050	9100							4.0
	6650 63°	6500 64°	6400 65°							
5.0	6900	6950	7000	7050	7100	7100	7150	7200		5.0
	5550 58°	5500 59°	5400 61°	5350 62°	5300 63°	5200 63°	5150 64°	5100 65°		
6.0	5500	5550	5600	5650	5700	5700	5750	5750	5800	6.0
	4750 53°	4700 55°	4650 56°	4600 57°	4550 58°	4500 60°	4450 61°	4400 61°	4350 62°	
7.0	4500	4550	4600	4650	4650	4700	4750	4750	4800	7.0
	3950 48°	3950 50°	4000 52°	4000 53°	3950 54°	3900 56°	3850 57°	3850 58°	3800 59°	
8.0	3750	3800	3850	3900	3900	3950	4000	4000	4050	8.0
	3250 43°	3300 45°	3350 47°	3350 48°	3400 50°	3450 51°	3400 53°	3350 54°	3350 55°	
9.0	3200	3250	3250	3300	3350	3350	3400	3400	3450	9.0
	2700 36°	2750 39°	2800 41°	2850 43°	2850 45°	2900 47°	2950 48°	2950 50°	2950 51°	
10	2700	2750	2800	2850	2850	2900	2900	2950	2950	10
	2300 29°	2350 32°	2400 35°	2400 38°	2450 40°	2450 42°	2500 44°	2550 45°	2550 47°	
11	2350	2350	2400	2450	2450	2500	2550	2550	2600	11
	1950 19°	2000 24°	2050 28°	2050 31°	2100 34°	2100 37°	2150 39°	2200 41°	2200 42°	
12	2050	2050	2100	2100	2150	2200	2200	2250	2250	12
	1700 (11.8)	1700 12°	1750 19°	1750 23°	1800 27°	1850 30°	1850 33°	1900 36°	1900 37°	
13	1950	1950	1850	1850	1850	1900	1950	1950	2000	13
	1600 (12.3)	1500 (12.8)	1500 11°	1500 18°	1550 23°	1600 27°	1600 27°	1650 30°	1650 32°	
14				1750	1650	1650	1700	1700	1750	14
				1450 (13.3)	1350 (13.8)	1350 11°	1400 18°	1400 22°	1450 25°	
15						1600	1500	1500	1550	15
						1300 (14.3)	1250 (14.8)	1250 11°	1250 16°	
15.71								1450	1400	15.71
								1150 (15.3)	1100 (15.7)	

- RC (kg) < than 10° articulation
- RC (kg) > than 10° articulation
- Boom angle
- Radius at 0° boom angle
- Loads above red line are structural

Notes to lifting capacity

Lifting capacities do not exceed 66.6% of tipping load. Weight of hook blocks and slings is part of the load, and is to be deducted from the capacity ratings. Consult Rated Capacity Manual for further details.

Data published herein is intended as a guide only and shall not be construed to warrant applicability for lifting purposes. Crane operation is subject to the computer charts and Rated Capacity Manual both supplied with the crane.

LOAD CHART

MAC 25-3

Fallblock, Rear Counterweight, Third Boom Retracted

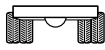

Pick & Carry 0.4 m/s (1.44 km/h); On rubber 66.6%



6.12-14.32 m

AS 1418.5

		Boom Length (m)																	
		6.12	6.50	7.00	7.50	8.00	8.50	9.00	9.50	10.00	10.50	11.00	11.50	12.00	12.50	13.00	13.50		
m	kg	kg	kg	kg	kg	kg	kg	kg	kg	kg	kg	kg	kg	kg	kg	kg	kg	kg	m
1.4	25000	25000	25000	25000	25000	25000	25000	25000											1.4
	21750	20200	18550	17250	16150	15200	14400	13700											
	48°	51°	54°	57°	59°	61°	63°	65°											
2.0	23000	22950	22850	22950	22900	22850	22800	22800	22150	19300									2.0
	19850	18700	17500	16150	15000	14100	13300	12600	12000	11450	10950								
	40°	44°	48°	51°	54°	57°	59°	61°	62°	64°	65°								
2.5	18200	18150	18150	18100	18050	18000	18000	17950	17950	17900	17750	15550	14600						2.5
	16250	16250	15600	14700	13900	13200	12400	11750	11150	10650	10200	9800	9400						
	32°	37°	42°	46°	50°	52°	55°	57°	59°	61°	62°	63°	65°						
3.0	14900	14900	14900	14850	14800	14800	14750	14750	14700	14700	14700	14350	13500	13000	12600	12250			3.0
	13300	13300	13250	13250	12500	11900	11400	10900	10400	9900	9500	9100	8750	8450	8150	7850			
	21°	29°	35°	41°	45°	48°	51°	53°	55°	57°	59°	61°	62°	63°	64°	65°			
3.5	12900	12550	12550	12500	12500	12500	12450	12450	12400	12400	12400	12350	12350	12150	11750	11400	10850		3.5
	11450	11150	11150	11150	11100	10800	10300	9900	9500	9200	8800	8450	8150	7850	7600	7350	6950		
	(3.4)	17°	28°	34°	39°	43°	47°	49°	52°	54°	56°	58°	59°	61°	62°	63°	65°		
4.0	11450	10800	10750	10750	10750	10700	10700	10700	10650	10650	10650	10650	10600	10600	10600	10600	10100		4.0
	10150	9550	9550	9550	9550	9400	9000	8650	8350	8100	7850	7550	7300	7050	6850	6500			
	(3.8)	17°	27°	33°	38°	42°	45°	48°	51°	53°	55°	56°	58°	59°	61°	62°			
5.0			9900	8700	8300	8300	8300	8250	8250	8250	8250	8200	8200	8200	8200	8200	8150		5.0
			8750	7700	7350	7300	7300	7300	7300	7100	6850	6600	6400	6250	6100	5950	5650		
			(4.3)	(4.8)	16°	25°	31°	36°	40°	43°	46°	48°	50°	52°	54°	56°	58°		
6.0					7700	6900	6650	6650	6650	6600	6600	6600	6600	6600	6600	6550	6550		6.0
					6800	6100	5850	5850	5800	5800	5800	5700	5550	5350	5200	5100	4900		
					(5.3)	(5.8)	15°	24°	30°	34°	38°	41°	44°	46°	48°	50°	53°		
7.0							6250	5650	5450	5450	5450	5450	5450	5400	5400	5400	5400		7.0
							5450	4950	4750	4750	4750	4750	4750	4700	4550	4450	4250		
							(6.3)	(6.8)	14°	23°	28°	33°	36°	39°	42°	44°	48°		
8.0									5150	4700	4550	4550	4550	4550	4550	4550	4550		8.0
									4500	4100	3950	3950	3950	3950	3950	3900	3750		
									(7.3)	(7.8)	14°	22°	27°	31°	35°	38°	42°		
9.0												4350	4000	3900	3900	3900	3900	3850	9.0
												3750	3450	3350	3350	3350	3350	3350	
												(8.3)	(8.8)	13°	21°	26°	30°	35°	
10														3700	3400	3350	3350	3350	10
														3150	2950	2850	2850	2850	
														(9.3)	(9.8)	12°	20°	28°	
11																3200	2950	2900	11
																2700	2500	2450	
																(10.3)	(10.8)	17°	
12																		2650	12
																		2200	
																		(11.6)	
13																			13
14																			14
15																			15
15.71																			15.71

- RC (kg) < than 10° articulation
- RC (kg) > than 10° articulation
- Boom angle
- Radius at 0° boom angle
- Loads above red line are structural

Notes to lifting capacity

Lifting capacities do not exceed 66.6% of tipping load. Weight of hook blocks and slings is part of the load, and is to be deducted from the capacity ratings. Consult Rated Capacity Manual for further details.

Data published herein is intended as a guide only and shall not be construed to warrant applicability for lifting purposes. Crane operation is subject to the computer charts and Rated Capacity Manual both supplied with the crane.



LOAD CHART

MAC 25-3

Fallblock, Rear Counterweight, Third Boom Extending

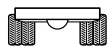

Pick & Carry 0.4 m/s (1.44 km/h); On rubber 66.6%



14.50–18.42 m

AS 1418.5

m	Boom Length (m)									m
	14.50	15.00	15.50	16.00	16.50	17.00	17.50	18.00	18.42	
kg	kg	kg	kg	kg	kg	kg	kg	kg	kg	kg
1.4										1.4
2.0										2.0
2.5										2.5
3.0										3.0
3.5	10750 6900 65°									3.5
4.0	10050 6450 63°	9850 6300 64°	9650 6150 65°							4.0
5.0	8200 5600 58°	8200 5500 59°	8250 5400 61°	8300 5300 62°	8250 5200 63°	8150 5100 63°	8000 5050 64°	7900 4950 65°		5.0
6.0	6550 4850 53°	6600 4800 55°	6650 4750 56°	6700 4650 57°	6750 4600 58°	6750 4550 60°	6800 4450 61°	6800 4400 61°	6850 4350 62°	6.0
7.0	5400 4250 48°	5450 4200 50°	5500 4150 52°	5550 4100 53°	5550 4050 54°	5600 4000 56°	5650 3950 57°	5650 3900 58°	5700 3850 59°	7.0
8.0	4550 3750 43°	4600 3700 45°	4650 3650 47°	4650 3600 48°	4700 3600 50°	4750 3550 51°	4750 3500 53°	4800 3500 54°	4800 3450 55°	8.0
9.0	3900 3350 36°	3900 3300 39°	3950 3250 41°	4000 3200 43°	4050 3200 45°	4050 3150 47°	4100 3150 48°	4100 3100 50°	4150 3100 51°	9.0
10	3350 2850 29°	3400 2900 32°	3400 2900 35°	3450 2900 38°	3500 2850 40°	3500 2850 42°	3550 2800 44°	3550 2800 45°	3600 2750 47°	10
11	2900 2450 19°	2950 2500 24°	3000 2550 28°	3000 2550 31°	3050 2600 34°	3050 2550 37°	3100 2550 39°	3150 2500 41°	3150 2500 42°	11
12	2600 2150 (11.8)	2550 2150 12°	2600 2200 19°	2650 2250 23°	2650 2250 27°	2700 2300 30°	2750 2300 33°	2750 2300 36°	2800 2300 37°	12
13		2450 2050 (12.3)	2350 1950 (12.8)	2300 1950 11°	2350 2000 18°	2400 2000 23°	2400 2050 27°	2450 2050 30°	2450 2100 32°	13
14				2200 1850 (13.3)	2100 1750 (13.8)	2100 1750 11°	2150 1800 18°	2150 1800 22°	2200 1850 25°	14
15						2050 1700 (14.3)	1950 1600 (14.8)	1950 1600 11°	1950 1650 16°	15
15.71								1850 1550 (15.3)	1800 1500 (15.7)	15.71

- RC (kg) < than 10° articulation
- RC (kg) > than 10° articulation
- Boom angle
- Radius at 0° boom angle
- Loads above red line are structural

Notes to lifting capacity





Lifting capacities do not exceed 66.6% of tipping load. Weight of hook blocks and slings is part of the load, and is to be deducted from the capacity ratings. Consult Rated Capacity Manual for further details.

Data published herein is intended as a guide only and shall not be construed to warrant applicability for lifting purposes. Crane operation is subject to the computer charts and Rated Capacity Manual both supplied with the crane.



Boom and Jib

	Four section boom: Main boom and three powered sections	
	Maximum hook height	18 m
	Boom elevation angle range (min. / max.)	-10° / 65°
	Maximum hook height with jib	22 m
	40° articulation each side of centre providing a total 80° slewing arc	80°
	Machinery hook	15 tonne

Winch

	Winch: Fully compensated hook height when telescoping boom 1 and 2 Anti two-block system	
	Maximum line pull	4.2 tonne
	Two speed winch	41 m/min / 82 m/min
	Hook block, two, four, or six part, maximum rated capacity	25 tonne



Engine and Transmission

	Mercedes OM 906 EUROMOT 3a turbo charged and intercooled diesel engine with hinged engine cover and mid cover for easy serviceability	205 kW
	Engine torque	1100 Nm
	Fuel capacity	440 l
	Fuel type	diesel
	Allison 3000	6-speed automatic
	Transfer Case: Styer VG 750 2:1 ratio High/low range via airshift 2WD/4WD via airshift, disconnect to rear axle	

Hydraulic System

	Hydraulic Pump: Load sensing axial piston Maximum pump flow rate Maximum working pressure	150 litre/min 250 bar
	Hydraulic tank with top mounted return and in-tank suction filters	380 l

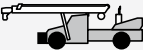
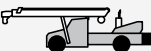
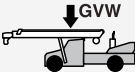
Chassis

	Drive axles: Kessler D71 PL477 heavy duty high speed planetary axle Front axle fitted with driver selectable diff lock and reinforced for pick and carry operation	
	Removable counterweight on front: Front axle Rear axle	11,900 kg 12,000 kg
	Removable counterweight on rear: Front axle Rear axle	9,900 kg 14,000 kg
	Total:	23,900 kg
	Full power Orbitrol with twin hydraulic double acting rams Priority flow from main pump supply plus electro-hydraulic emergency supply Turning Circle: Outside wheels radius	7.9 m
	Brakes: Air operated high capacity Large wedge style twin circuit service and spring applied park brakes on both front and rear axles Crane operation hold brake on right side front wheel Driver selectable engine exhaust brake is available in all gears - automatically selects converter lockup	
	Suspension: Two semi-elliptic springs on front and rear axle with automatic hydraulic spring lockouts on front axle	



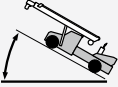

Tyres

	14.00 x 20 bias ply duals 20 in x 10 in heavy duty ISO 10 stud 335 PCD spigot mount rims
---	---

Vehicle performance

	Maximum rated travel speed	75 kph
	Gradeability	45%

Cab, Controls, and Operator aids

	Two person, insulated lock up cabin: <ul style="list-style-type: none">KAB suspension driver's and passenger seats, including retracting seat beltsColour LCD displayRadio/CD player with Bluetooth handsfreeReversing cameraCentralised greasingCruise controlEngine monitoringService diagnostics
	3B6 rated capacity indicator with audio/visual overload pre-warning and motion cut-outs
	3 pilot control levers for crane functions
	Air conditioned and heated

BRISBANE

585 Curtin Avenue East
Eagle Farm QLD 4009
AUSTRALIA

Ph: +61 7 3868 9600
Fax: +61 7 3268 2489

MELBOURNE

187 Osborne Avenue
Clayton South VIC 3169
AUSTRALIA

Ph: +61 3 9551 8644
Fax: +61 3 9551 8143

SYDNEY

114 Hassall Street
Wetherill Park NSW 2164
AUSTRALIA

Ph: +61 2 8786 4444
Fax: +61 2 8786 4455

PERTH

39 Catalano Road
Canning Vale WA 6155
AUSTRALIA

Ph: +61 8 9232 0000
Fax: +61 8 9232 0051

www.terexcranes.com

Effective Date: September 2011. Product specifications and prices are subject to change without notice or obligation. The photographs and/or drawings in this document are for illustrative purposes only. Refer to the appropriate Operator's Manual for instructions on the proper use of this equipment. Failure to follow the appropriate Operator's Manual when using our equipment or to otherwise act irresponsibly may result in serious injury or death. The only warranty applicable to our equipment is the standard written warranty applicable to the particular product and sale and Terex makes no other warranty, express or implied. Products and services listed may be trademarks, service marks or trade-names of Terex Corporation and/or its subsidiaries in the USA and other countries. All rights are reserved. Terex® is a registered trademark of Terex Corporation in the USA and many other countries. Copyright 2011 Terex Corporation..

Terex Cranes, Global Marketing, Dinglerstraße 24, 66482 Zweibrücken, Germany
Tel. +49 (0) 6332 830, Email: info.cranes@terex.com, www.terexcranes.com

Brochure Reference: TC-DS-M-E-MAC25-3-09/11



WORKS FOR YOU.™